



Shadowspec
SERENITYTM
Single Canopy Rotating Cantilever Umbrella



Precision Engineered Ambience



10 YEAR
Fabric
Warranty*
BEST-IN-CLASS



6 YEAR
Frame
Warranty*
BEST-IN-CLASS



Trusted for
over 25 years



Hand-built in
New Zealand



Marine
Grade

SHADOWSPEC SERENITY™ Single Canopy Rotating Cantilever Umbrella

Patented & Trademarked Technology



SHADOWLIFT™

Gas-assisted deployment for an easy lift.



SHADOWGLIDE™

Engineered to open or close in 5 seconds.



SHADOWHUB™

LED light technology built-in and app controlled.



SHADOWLOCK™

Integrated security and wind-protection.

Canopy



Stock Colours

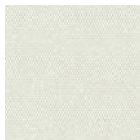

Oyster

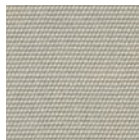

Alpine Stone

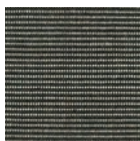

Charcoal Tweed

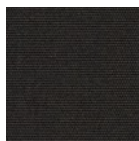

Black

Special-Order Colours**



Natural



Storm

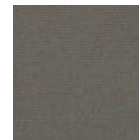

Charcoal



Slate



Taupe

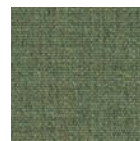

Fern



Linen



Sunflower Yellow



Captain Navy



Terracotta

**Special-Order Colours are non-stock and will incur an additional lead time and surcharge. Full Sunbrella Marine Range or other identical fabrics are available as a custom colour option.



RECASENS
BCN 1886

Solution Dyed Acrylic

Some fabric dyeing methods only coat the outer surface of the fibre – think of a radish.

With the Solution Dyed method, each individual thread fibre is dyed – think of a beetroot. The fabric is also easy to clean and covered by a 10 year warranty.

Frame Colour



Space Grey



Heron Black***

***Available in 3.0m Square or 4.0m Octagon sizes only.



Marine Grade



Solution-dyed, High Colour Fastness



UV and Fade Resistant



UPF 80 UV Protection



Eco-friendly Production



Breathable Weave



Mould and Mildew Resistant



Oil and Stain Repellent



Easy Clean



Water Resistant



Chlorine Resistant



Tear Resistant

Size & Configuration

SQUARE

2.5m | 8'

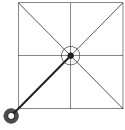

SQUARE

3.0m | 10'

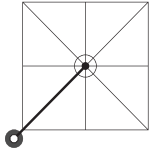

OCTAGON

3.5m | 11'

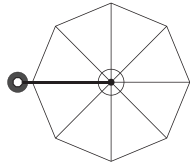

OCTAGON

4.0m | 13'

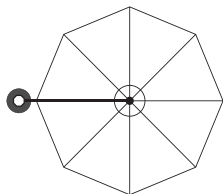

All sizings and conversions are approximate and subject to change without notice. Refer to specsheets for exact, up-to-date measurements.

Features



EASY OPEN & CLOSE

Umbrella deployment system with no winding or cables.



MARINE GRADE

No-rust, 316 Stainless Steel Spigot.

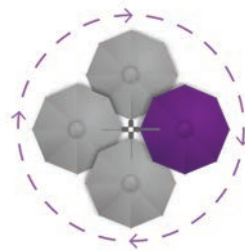

FOLLOW THE SUN

Enjoy the 360° rotation for all-day-shade.

Accessories

N.b. Accessories are optional. Pricing additional.



LED LIGHT CONTROL

Power your light with the Smart Battery or Hardwire Kit.



PROTECTION COVER

Recommended, optional care and protection for your umbrella.



CASTOR WHEELS FOR FREE-STANDING BASE

Mounting Options

SURFACE PLATE

For deck, patio and concrete mounting. (316 stainless steel)



IN-GROUND ANCHOR

For mounting with a concrete footing.



WALL MOUNT BRACKET

For when ground mounting isn't possible. (316 stainless steel)



FREE-STANDING BASE + ALUMINIUM BASE COVER

For complete customised manoeuvrability.



Note: Fastenings are not supplied for the Surface Plate or Wall Mount Bracket..

Available in Space Grey or Heron Black. Concrete pavers (not included) are required for ballast. Optional Castor Wheels available.

Dimensions

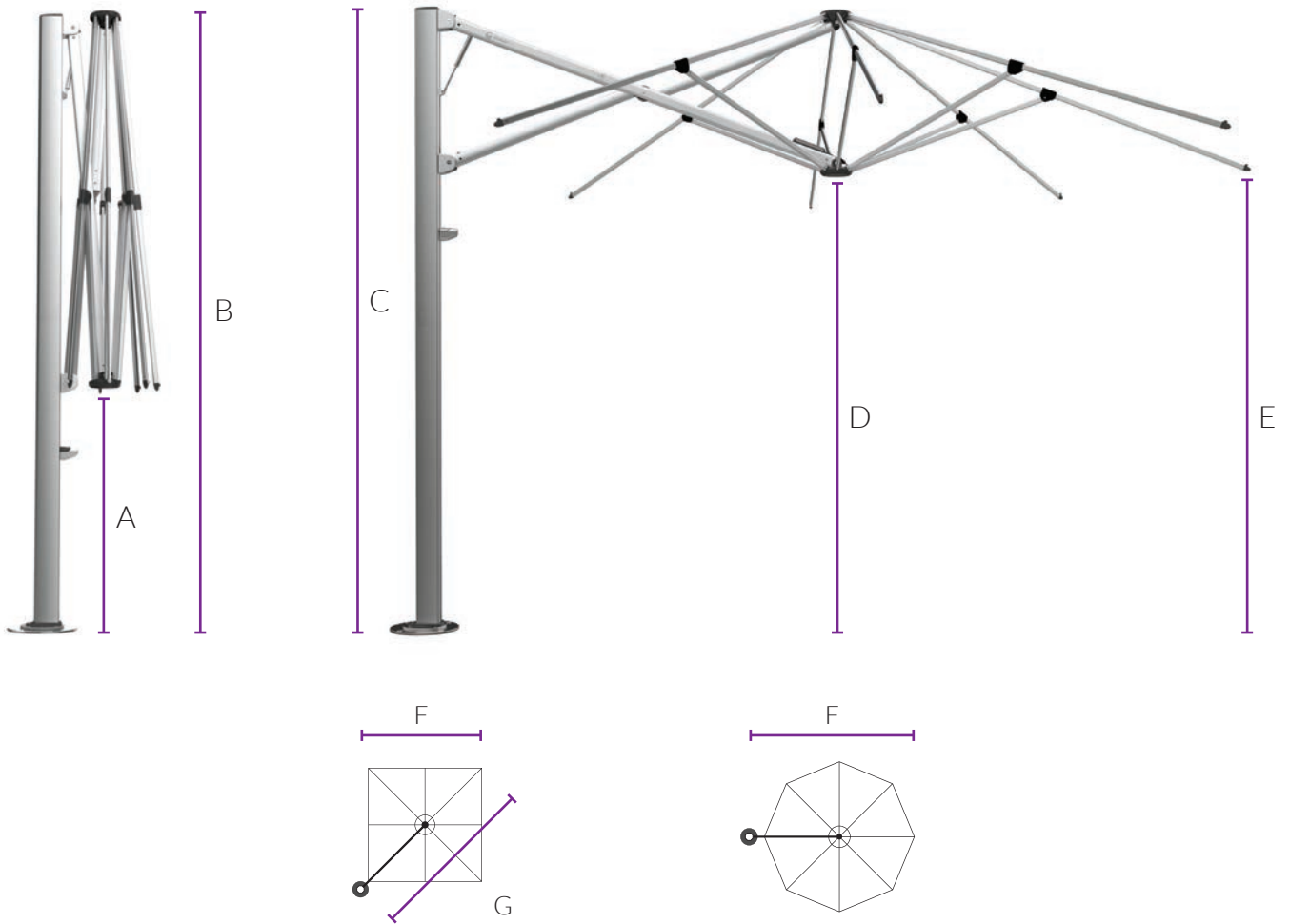

Diagram Legend

	2.5m	8'	3.0m	10'	3.5m	11'	4.0m	13'
A Ground to central frame hub when closed†	860mm	2'10"	620mm	2'1"	1079mm	3'7"	866mm	2'10"
B Total height to top of canopy†	2900mm	9'6"	2824mm	9'3"	2975mm	9'9"	2899mm	9'6"
C Height of umbrella to top of mast cap†	2908mm	9'6"	2908mm	9'6"	2908mm	9'7"	2908mm	9'6"
D Ground to central frame hub when open†	2130mm	7'0"	2054mm	6'9"	2205mm	7'3"	2128mm	7'0"
E Ground to lower outer edge of canopy†	2222mm	7'3"	2219mm	7'3"	2237mm	7'4"	2172mm	7'2"
F Centre of Spigot to outside edge of canopy	2646mm	8'8"	2973mm	9'10"	3447mm	11'4"	3923mm	12'10"
G Diagonal from centre of mast to corner	3742mm	12'3"	4205mm	13'10"	N/A	N/A	N/A	N/A

†Free-standing Base installations will add 165mm | 6" to the height and surface plates will add 12mm | 1/2" to the height. Adding the optional Castor Wheels to the Free-standing Base will increase height a further 45-80mm | 2-3" to the height. All sizings and conversions are approximate and subject to change without notice. Refer to specsheets for exact, up-to-date measurements.



shadowspec
umbrellas with distinction